

586753045 - ZIPPER LOCK WIRED 105

Self closing ventilated fuel cap. Features quick mount 105 bayonet, lock, built in electronic activation switch and wire connection which can be used to trigger events upon fuel cap opening. Applicable current range 5-30V 1-100mA.

For tank necks with bayonet fitting 105mm.-DAF: all models -MAN: all models-VOLVO: all models -MERCEDES: all models-IVECO: Stralis, EuroStar, EuroTec, Trakker, EuroTrakker, EuroCargo with metal fuel tanks-RENAULT: Premium, Magnum, Midlum with metal fuel tanks-LAMBERET: reefer semi-trailer SR2-DOOSAN plant machinery BI2P-LIEBHERR excavators, mod. 2926 – 2916 – 2914

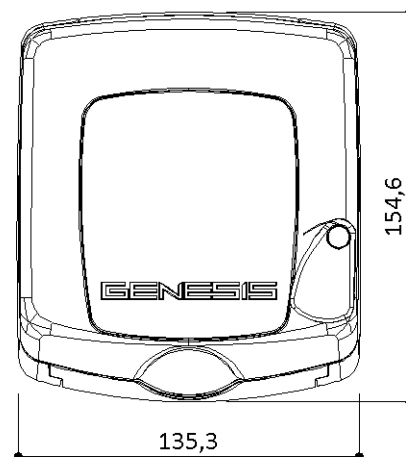
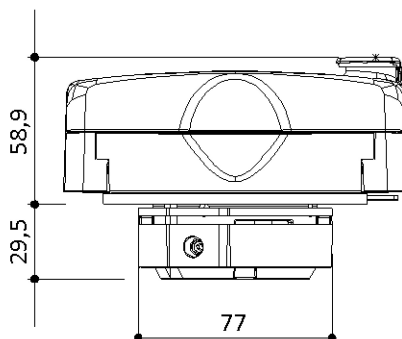

TECHNICAL DATA

Main Body Material	POM Acetalic Resin
Gasket material	NBR rubber
Weight	865 g
Reference standard	ECE R34 Part III
Package type	Carton Box
Multipack	12 pcs in master carton box

SPARE PARTS

code	item	description
050707038	GUAR GHIERA ZIPPER105 ALT NIT 70SH AR	Gasket for devices bearing 105 mount
056802005	COPRITOPPA TAPPO ZIPPER RAL5008	Replacement part
584500001	ADATTATORE UGELLO PISTOLA Ø 25 MM	Adapter for nozzle Ø 25 mm