

## 584595001 - STROPOL ANTIFURTO TAPPO SCARICO M18 AL

High security drain plug for heavy vehicle tanks STROPOL is a small, highly engineered device which is dedicated to the big job of protecting the main drain hole of tanks of heavy vehicles against removal and access by non authorized operators. STROPOL is made of precision Machined aluminium components and simply replaces the original drain nut. Once tightened through clockwise rotation using a hexagon allen key, the crown of STROPOL will rotate freely in the anti clockwise sense, making removal impossible for non authorized operators. STROPOL must be installed on an empty tank.

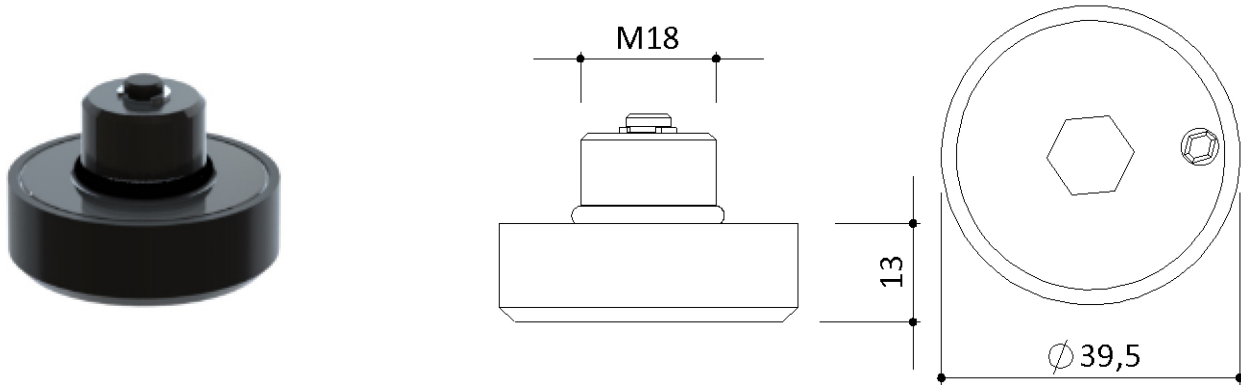

---

**TECHNICAL DATA**

Main Body Material	Aluminium
Weight	48 g
Package type	Carton Box
Package contents	1 pc in carton box